

# Introduce of AL8800

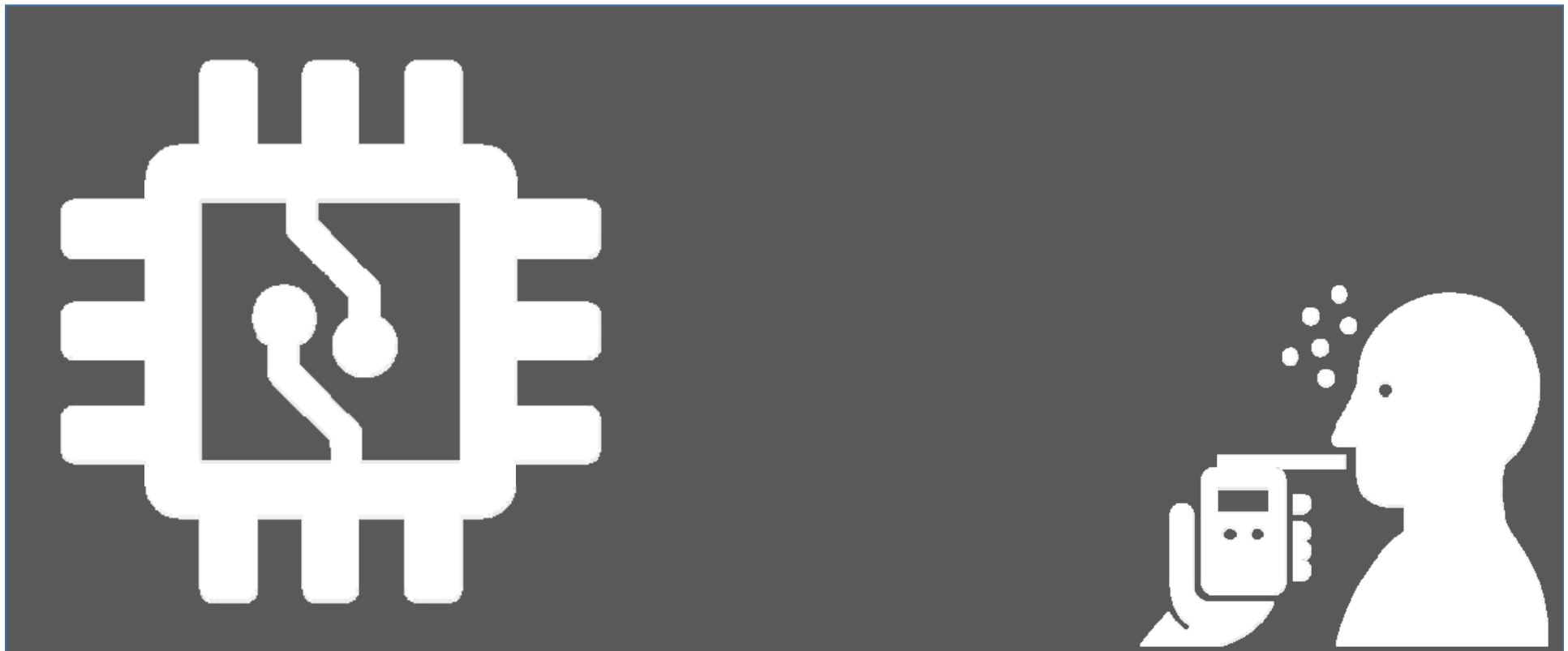

The innovative technology of **SENTECH KOREA** opens up a happier future



The new  
Fuel cell Breathalyzer **AL8800**

Background

Product  
concept

Summary

# Let's Jump-up with new breathalyzer



The new Fuel cell Breathalyzer **AL8800**



# Yearly sales data (AL6000 Series)

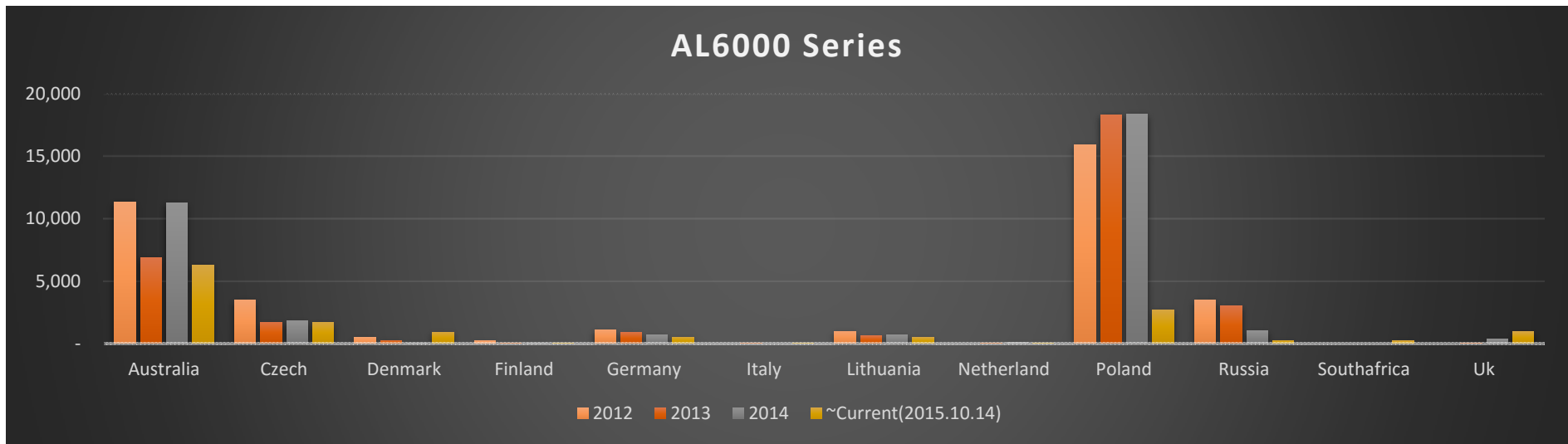
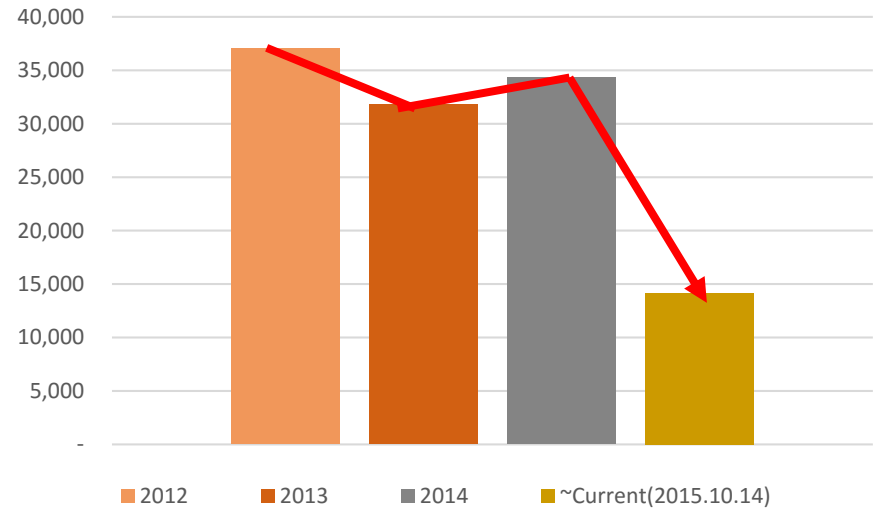

The new Fuel cell Breathalyzer **AL8800**



# Yearly sales data (AL7000 Series)

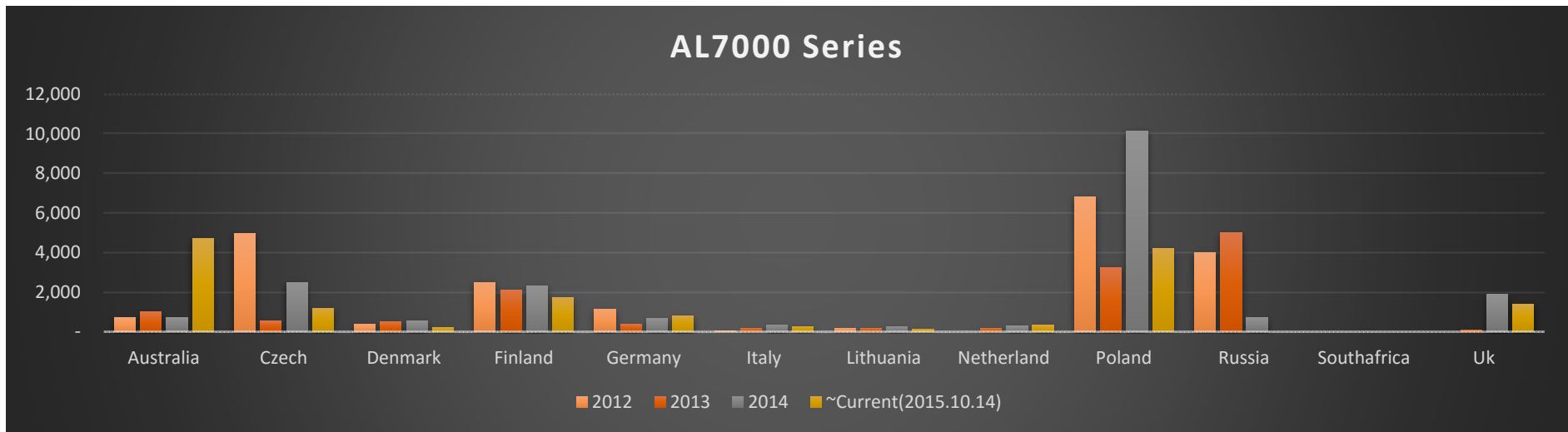
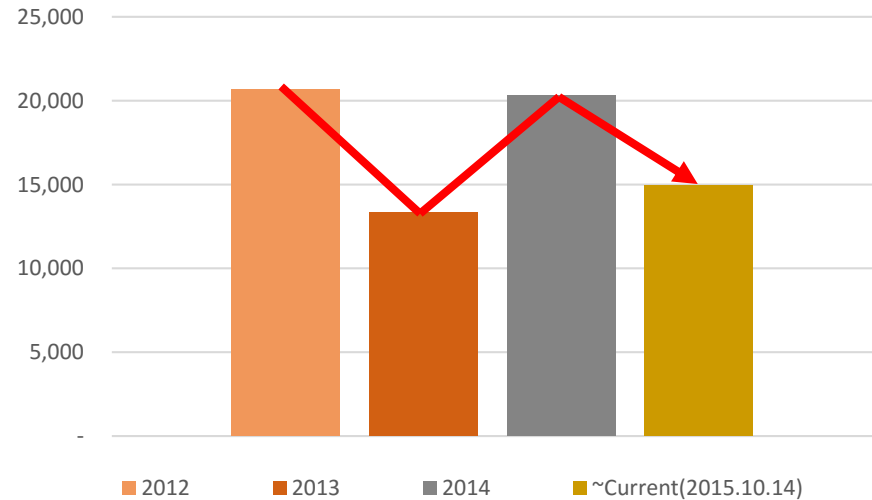

# Market demands

With portable breathalyzers...

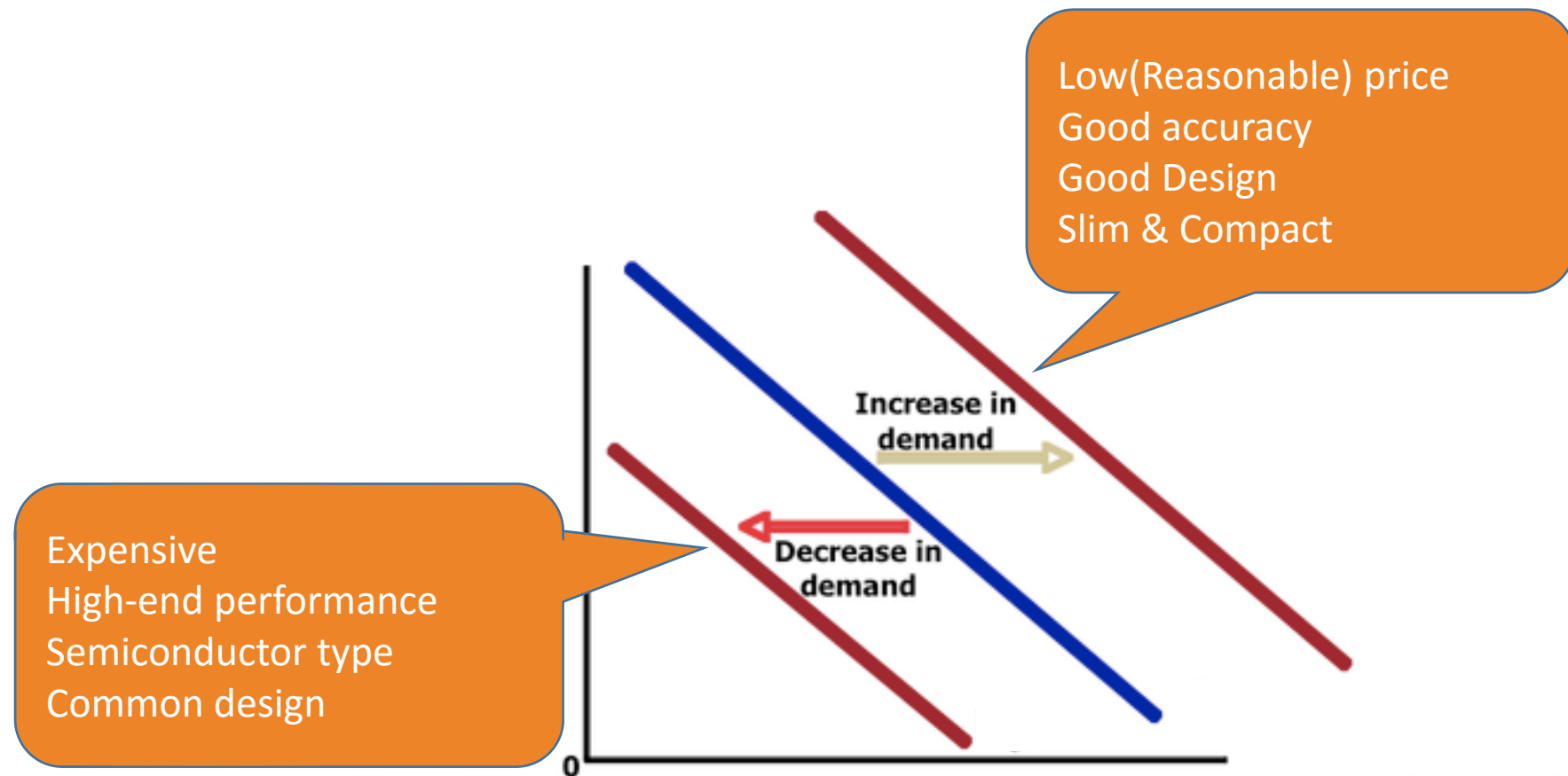

## BCG Matrix

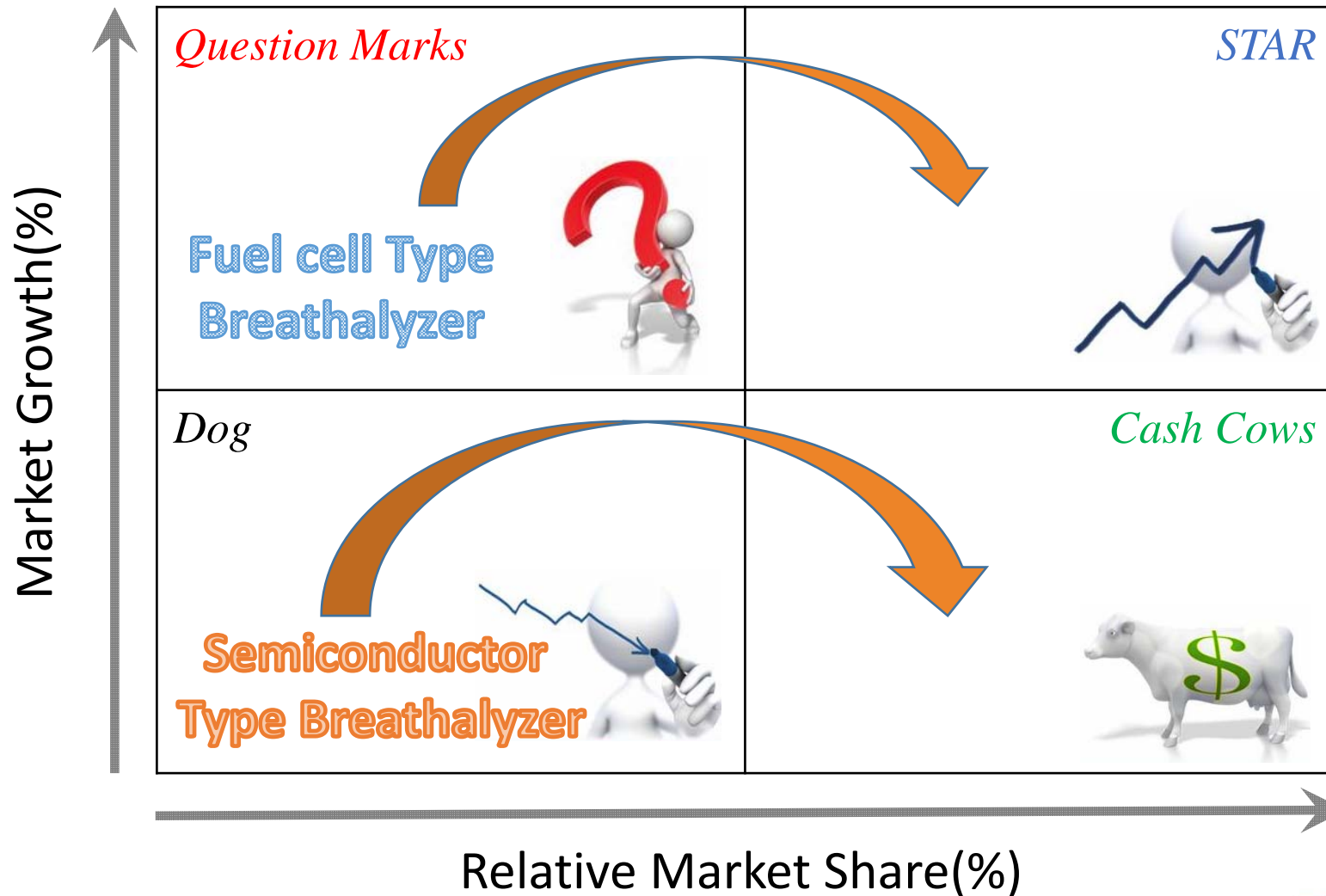

## Cost saving

We need to... SAVE  
Labor cost  
Material cost  
Other related cost



•  
•  
•



Solution is  
Simple processing sequence  
Minimum package  
Fixed contents

## Supplying conditions



Supplier agree with

1. Keep price condition
2. Quality assurance
3. Delivery on request

Provider agree with

- Pre-order with MOQ

The new  
Fuel cell Breathalyzer **AL8800**

Background

**Product  
concept**

Summary

## Basic requirements



Price

Design &  
Quality



**SENTECH**  
KOREA CORP.

The new  
Fuel cell Breathalyzer **AL8800**

Background

**Product  
concept**

Summary

## Basic requirements

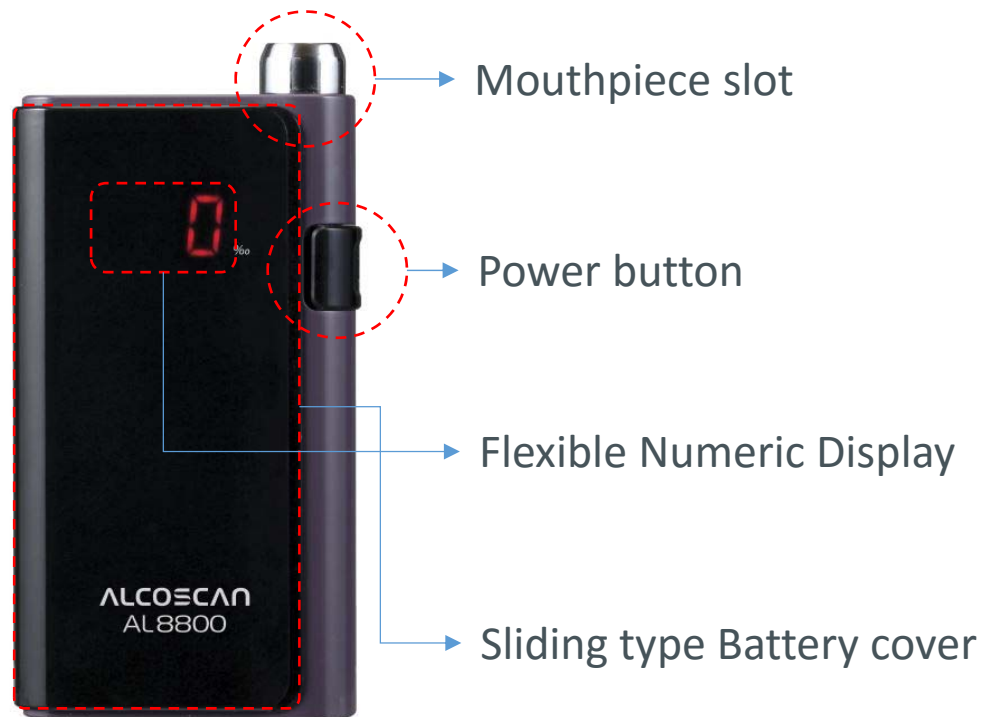

The new  
Fuel cell Breathalyzer **AL8800**

Background

**Product  
concept**

Summary

## Basic requirements

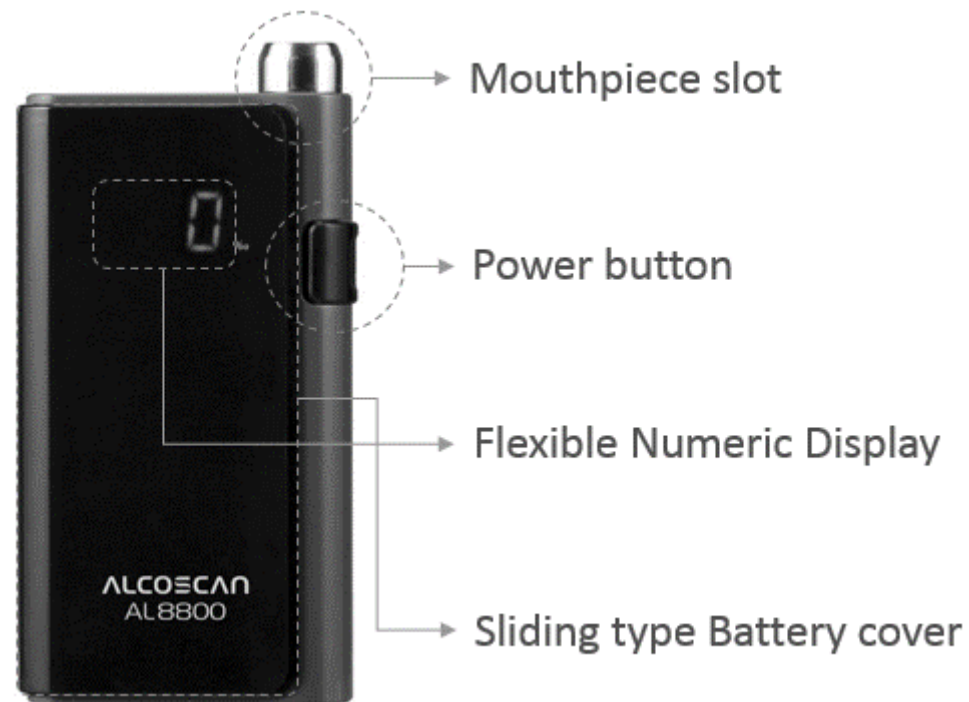

## Basic requirements



The new  
Fuel cell Breathalyzer **AL8800**

Background

**Product  
concept**

Summary

New release



# AL8800



The new  
Fuel cell Breathalyzer **AL8800**

Background

**Product  
concept**

Summary

## Naming : Why it is called AL8800?

# AL8800

AL Series : General portable breathalyzer line-ups



AL8000



AL8800

Similar features  
With different design.

To add 800 means  
New Family line-up

## AL8000 NFC Release & Price issue

We have to ...

Release only with NFC function.

Same price condition with former AL8000 model.



Discontinued



Supply with NFC options

## Internal structure

Cross-sectional view

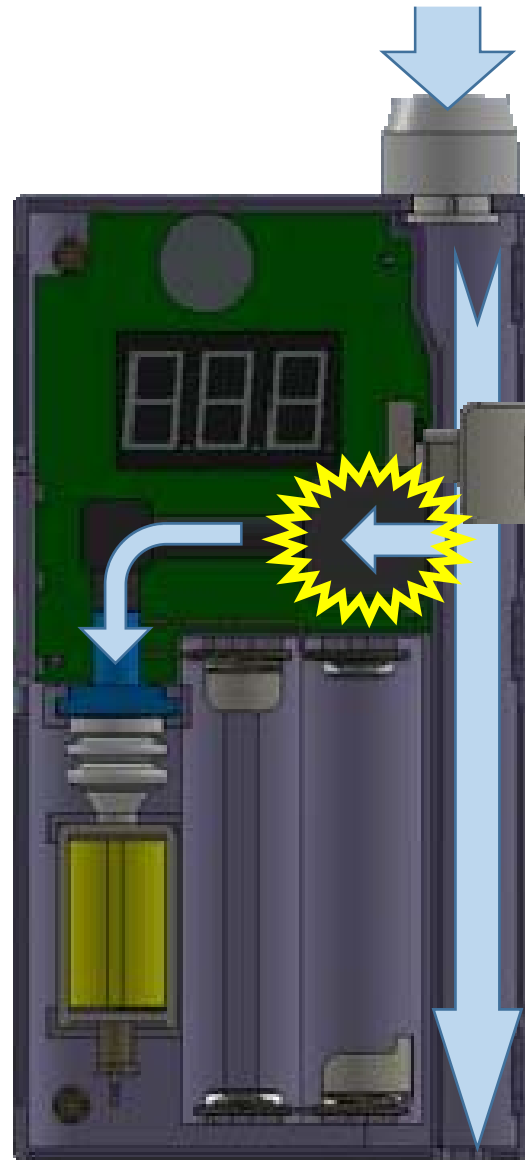

The new  
Fuel cell Breathalyzer **AL8800**

Background

**Product  
concept**

Summary

Rendering image (마우스피스 삽입부 수정요청)



## Front slide cover : introduction for use

Step 1. The cover slide is closed

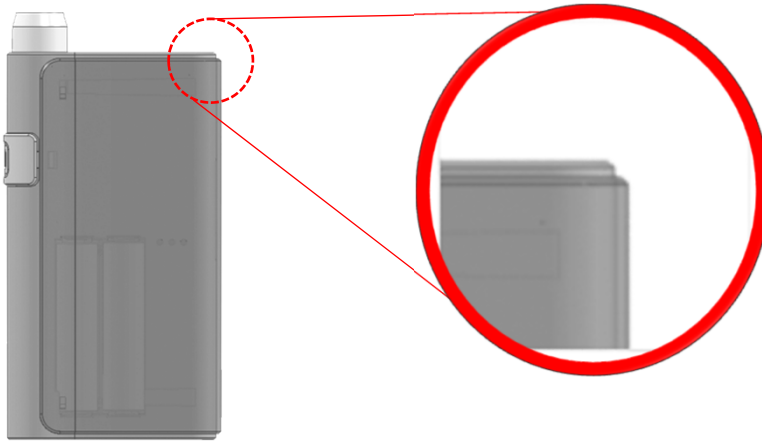

Step 2. Slide up for cover release

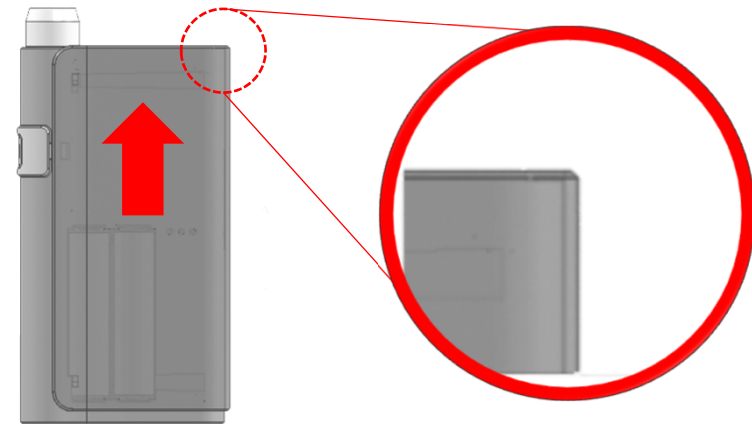

Step 3. Remove the cover slide

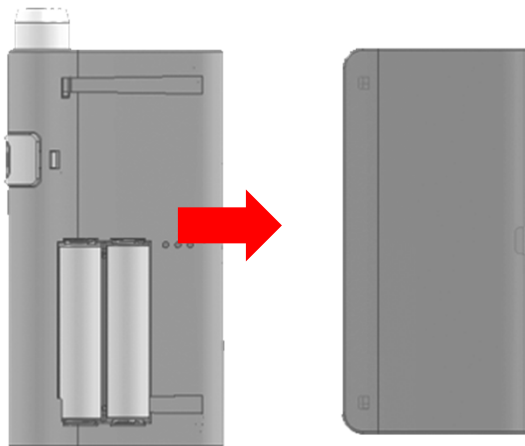

Step 4. Remove the battery

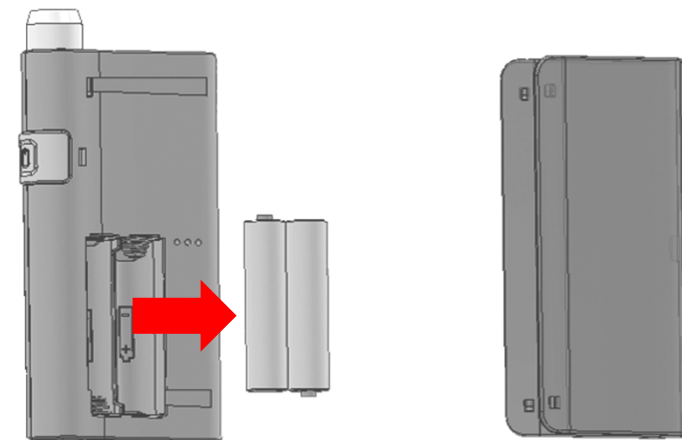

## Blowing Direction for detect

Blowing to horizontal direction



Right to use



Blocking sampling tube

## Blowing Direction for detect

Blowing to horizontal direction

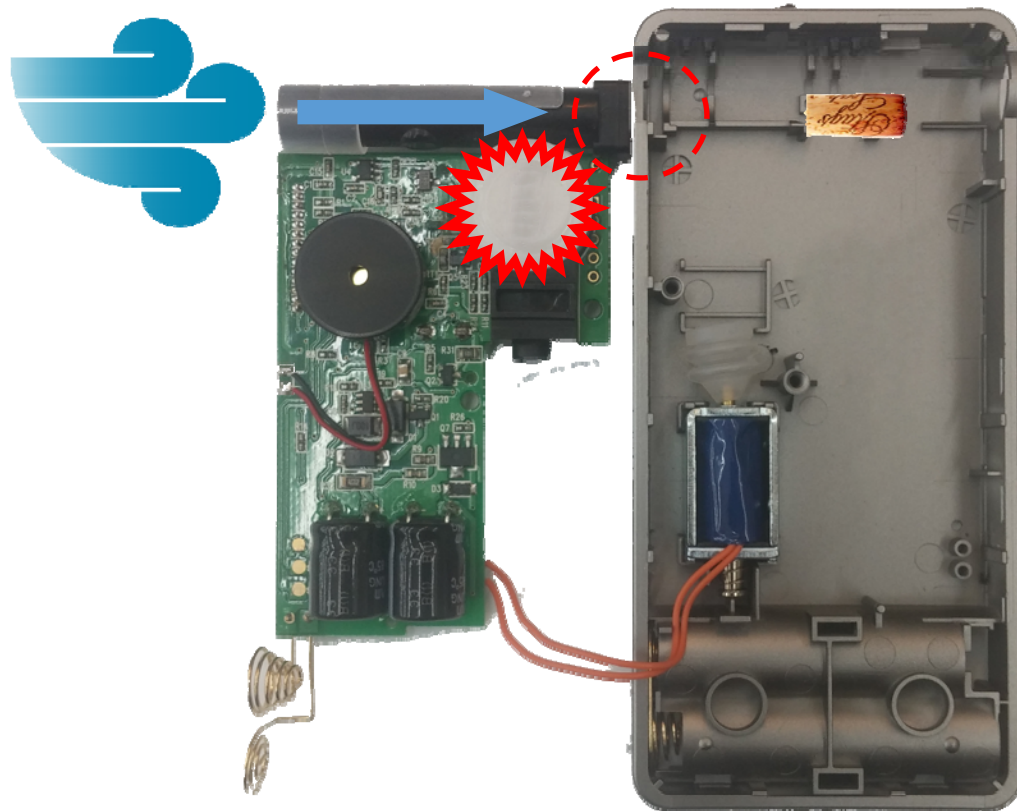

Blocking sampling tube  
may cause...

1. Sensor damage
2. Reducing sensor life cycle
3. Decrease sensor accuracy

## Blowing Direction for detect

Blowing to vertical direction

Stable position from  
Blocking ventilation



# Specification

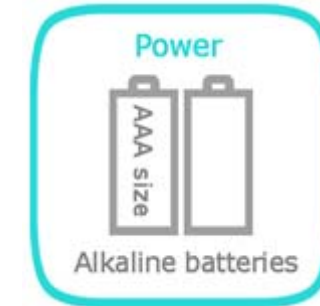

# Thank you.

The innovative technology of **SENTECH KOREA** opens up a happier future

